

# HEATHKIT<sup>®</sup> MANUAL

for the

**PAN ADAPTOR  
MODULE**  
Model HOA-5404-1

595-3437



HEATH COMPANY • BENTON HARBOR, MICHIGAN



# HEATH COMPANY PHONE DIRECTORY

The following telephone numbers are direct lines to the departments listed:

Kit orders and delivery information ..... (616) 982-3411  
Credit ..... (616) 982-3561  
Replacement Parts ..... (616) 982-3571

## Technical Assistance Phone Numbers

8:00 A.M. to 12 P.M. and 1:00 P.M. to 4:30 P.M., EST, Weekdays Only  
R/C, Audio, and Electronic Organs ..... (616) 982-3310  
Amateur Radio ..... (616) 982-3296  
Test Equipment, Weather Instruments and  
Home Clocks ..... (616) 982-3315  
Television ..... (616) 982-3307  
Aircraft, Marine, Security, Scanners, Automotive,  
Appliances and General Products ..... (616) 982-3496  
Computers — Hardware ..... (616) 982-3309  
Computers — Software:  
Operating Systems, Languages, Utilities ..... (616) 982-3860  
Application Programs ..... (616) 982-3884  
Heath Craft Wood Works ..... (616) 982-3423



## YOUR HEATHKIT 90-DAY LIMITED WARRANTY

### Consumer Protection Plan for Heathkit Consumer Products

Welcome to the Heath family. We believe you will enjoy assembling your kit and will be pleased with its performance. Please read this Consumer Protection Plan carefully. It is a "LIMITED WARRANTY" as defined in the U.S. Consumer Product Warranty and Federal Trade Commission Improvement Act. This warranty gives you specific legal rights, and you may also have other rights which vary from state to state.

#### Heath's Responsibility

**PARTS** — Replacements for factory defective parts will be supplied free for 90 days from date of purchase. Replacement parts are warranted for the remaining portion of the original warranty period. You can obtain warranty parts direct from Heath Company by writing or telephoning us at (616) 982-3571. And we will pay shipping charges to get those parts to you . . . anywhere in the world.

**SERVICE LABOR** — For a period of 90 days from the date of purchase, any malfunction caused by defective parts or error in design will be corrected at no charge to you. You must deliver the unit at your expense to the Heath factory, any Heathkit Electronic Center (units of Veritechnology Electronics Corporation), or any of our authorized overseas distributors.

**TECHNICAL CONSULTATION** — You will receive free consultation on any problem you might encounter in the assembly or use of your Heathkit product. Just drop us a line or give us a call. Sorry, we cannot accept collect calls.

**NOT COVERED** — The correction of assembly errors, adjustments, calibration, and damage due to misuse, abuse, or negligence are not covered by the warranty. Use of corrosive solder and/or the unauthorized modification of the product or of any furnished component, will void this warranty in its entirety. This warranty does not include reimbursement for inconvenience, loss of use, customer assembly, set-up time, or unauthorized service.

This warranty covers only Heath products and is not extended to other equipment or components that a customer uses in conjunction with our products.

SUCH REPAIR AND REPLACEMENT SHALL BE THE SOLE REMEDY OF THE CUSTOMER AND THERE SHALL BE NO LIABILITY ON THE PART OF HEATH FOR ANY SPECIAL, INDIRECT, INCIDENTAL OR CONSEQUENTIAL DAMAGES, INCLUDING BUT NOT LIMITED TO ANY LOSS OF BUSINESS OR PROFITS, WHETHER OR NOT FORSEEABLE.

Some states do not allow the exclusion or limitation of incidental or consequential damages, so the above limitation or exclusion may not apply to you.

#### Owner's Responsibility

**EFFECTIVE WARRANTY DATE** — Warranty begins on the date of first consumer purchase. You must supply a copy of your proof of purchase when you request warranty service or parts.

**ASSEMBLY** — Before seeking warranty service, you should complete the assembly by carefully following the manual instructions. Heathkit service agencies cannot complete assembly and adjustments that are customer's responsibility.

**ACCESSORY EQUIPMENT** — Performance malfunctions involving other non-Heath accessory equipment, (antennas, audio components, computer peripherals and software, etc.) are not covered by this warranty and are the owner's responsibility.

**SHIPPING UNITS** — Follow the packing instructions published in the assembly manuals. Damage due to inadequate packing cannot be repaired under warranty.

If you are not satisfied with our service (warranty or otherwise) or our products, write directly to our Director of Customer Service, Heath Company, Benton Harbor MI 49022. He will make certain your problems receive immediate, personal attention.

### TABLE OF CONTENTS

Introduction .....	3	Operation .....	28
Assembly Notes .....	4	Reversing the Screen Display .....	28
Parts List .....	7	In Case of Difficulty .....	29
Step-by-Step Assembly .....	10	Visual Checks .....	29
Circuit Board Assembly .....	10	Troubleshooting Chart .....	30
Circuit Board Checkout .....	21	Specifications .....	31
Installation in Station Monitor .....	22	Circuit Description .....	32
Tests and Adjustments .....	24	Semiconductor Identification Charts .....	33
Initial Tests .....	24	Circuit Board X-Ray View .....	35
Adjustments .....	24	Schematic Diagram . Illustration Booklet, Page 14	
Installation .....	26	Warranty .....	Inside front cover
SS-9000 Transceiver .....	26	Customer Service .....	Inside rear cover
HW-5400 Transceiver .....	26		
HW-99, SB-104A & HW-101 Transceivers ..	27		
Other Transceivers and Receivers .....	27		

## INTRODUCTION

The Heathkit Model HOA-5404-1 is a Pan Adaptor Module for use with the Heathkit Model HO-5404 Station Monitor. It allows you to view signals  $\pm 20$  kHz (nominal) or  $\pm 100$  kHz (nominal) from the tuned frequency on a particular band (during the receive mode only).

A logarithmic compression IF enables the Module to simultaneously display weak as well as strong signals, while the narrow 1 kHz, 455 kHz IF filter allows you to monitor adjacent signals under varying band conditions. A built-in marker oscillator quickly shows the actual receiver frequency on the display.

All parts are included so you can assemble the Module to work with Heathkit and other non-Heath receivers and transceivers that use either a 3.395 or an 8.830 MHz IF. The Module fits completely inside the Station Monitor and obtains all of its operating voltages from the Monitor. Only a single shielded cable is required to connect it to your receiver.

This Pan Adaptor Module is easy to assemble and align, and provides you with a handy uncalibrated spectrum monitor to aid you in locating open or occupied frequencies as you tune through crowded bands.



## ASSEMBLY NOTES

### TOOLS

You will need these tools to assemble your kit.

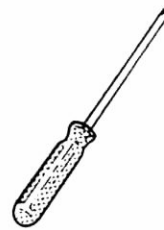

PLIERS

LONG-NOSE  
PLIERSDIAGONAL  
CUTTERSWIRE  
STRIPPERSPHILLIPS  
SCREWDRIVER

### OTHER HELPFUL TOOLS

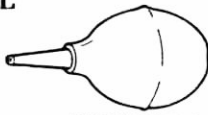
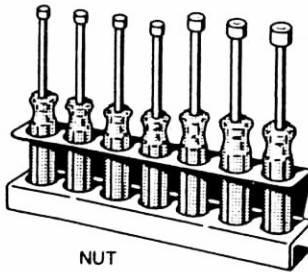
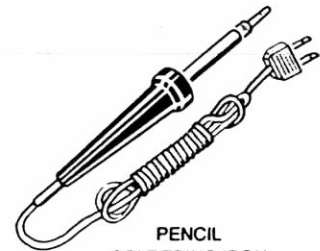
NUT STARTER  
(May Be Supplied  
With Kit)DESOLDERING  
BULB\*DESOLDERING  
BRAID\*NUT  
DRIVERSPENCIL  
SOLDERING IRON  
(22 to 25 WATTS)

\*To Remove Solder From Circuit Connections.

### ASSEMBLY

1. Follow the instructions carefully. Read the entire step before you perform each operation.
2. Refer to the separate "Illustration Booklet" for the Pictorials and Details. Keep the "Illustration Booklet" with the Assembly Manual. The illustrations in it are arranged in the proper sequence, as called for in the steps.
3. Pictorials show the overall operation for a group of assembly steps; Details generally illustrate a single step. When you are directed to refer to a certain Pictorial "for the following steps," continue using that Pictorial until you are referred to another Pictorial for another group of steps.
4. Position all parts as shown in the Pictorials.
5. Solder instructions are generally given only at the end of a series of similar steps. You may solder more often if you desire.

6. Each circuit part in an electronic kit has its own component number (R2, C4, etc.). Use these numbers when you want to identify the same part in the various sections of the Manual. These numbers, which are especially useful if a part has to be replaced, appear:
- In the Parts List,
  - At the beginning of each step where a component is installed,
  - In some illustrations,
  - In Troubleshooting Charts,
  - In the Schematic,
  - In the sections at the rear of the Manual.
7. When you are instructed to cut something to a particular length, use the scales (rulers) provided at the bottom of the Manual pages.

**SAFETY WARNING: Avoid eye injury when you cut off excessive lead lengths. Hold the leads so they cannot fly toward your eyes.**

## SOLDERING

Soldering is one of the most important operations you will perform while assembling your kit. A good solder connection will form an electrical connection between two parts, such as a component lead and a circuit board foil. A bad solder connection could prevent an otherwise well-assembled kit from operating properly.

It is easy to make a good solder connection if you follow a few simple rules:

1. Use the right type of soldering iron. A 22 to 25-watt pencil soldering iron with a 1/8" or 3/16" chisel or pyramid tip works best.
2. Keep the soldering iron tip clean. Wipe it often on a wet sponge or cloth; then apply solder to the tip to give the entire tip a wet look. This process is called tinning, and it will protect the tip and enable you to make good connections. When solder tends to "ball" or does not stick to the tip, the tip needs to be cleaned and retinned.

NOTE: Always use rosin core, radio-type solder (60:40 tin-lead content) for all of the soldering in this kit. This is the type we have supplied with the parts. The Warranty will be void and we will not service any kit in which acid core solder or paste has been used.

**PARTS**

**Resistors** are identified in Parts Lists and steps by their resistance value in  $\Omega$  (ohms),  $k\Omega$  (kilohms), or  $M\Omega$  (megohms). They are usually identified by a color code of four or five color bands, where each color represents a number. These colors (except for the last band, which indicates a resistor's "tolerance") will be given in the steps in their proper order. Therefore, the following color code is given for information only. NOTE: Occasionally, a "precision" or "power" resistor may have the value stamped on it.

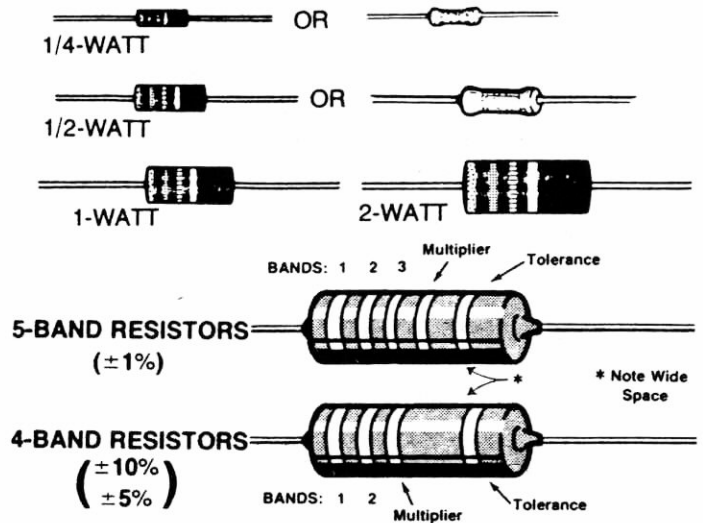

Band 1 1st Digit		Band 2 2nd Digit		Band 3 (if used) 3rd Digit		Multiplier		Resistance Tolerance	
Color	Digit	Color	Digit	Color	Digit	Color	Multiplier	Color	Tolerance
Black	0	Black	0	Black	0	Black	1	Silver	$\pm 10\%$
Brown	1	Brown	1	Brown	1	Brown	10	Gold	$\pm 5\%$
Red	2	Red	2	Red	2	Red	100	Red	$\pm 2\%$
Orange	3	Orange	3	Orange	3	Orange	1,000	Brown	$\pm 1\%$
Yellow	4	Yellow	4	Yellow	4	Yellow	10,000	Green	$\pm .5\%$
Green	5	Green	5	Green	5	Green	100,000	Blue	$\pm .25\%$
Blue	6	Blue	6	Blue	6	Blue	1,000,000	Violet	$\pm .1\%$
Violet	7	Violet	7	Violet	7	Silver	0.01	Gray	$\pm .05\%$
Gray	8	Gray	8	Gray	8	Gold	0.1		
White	9	White	9	White	9				

**Capacitors** will be called out by their capacitance value in  $\mu F$  (microfarads) or pF (picofarads) and type: ceramic, Mylar\*, electrolytic, etc. Some capacitors may have their value printed in the following manner:

EXAMPLES:

151K =  $15 \times 10 = 150 \text{ pF}$   
 759 =  $75 \times 0.1 = 7.5 \text{ pF}$

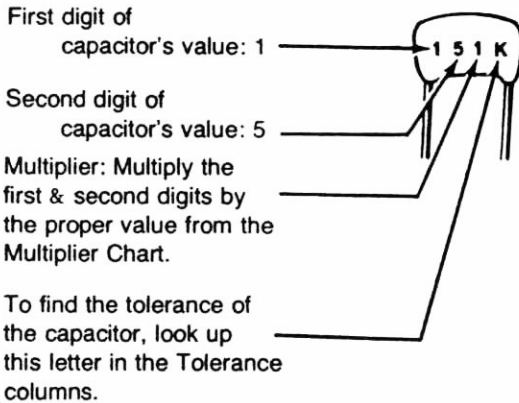

NOTE: The letter "R" may be used at times to signify a decimal point: as in: 2R2 = 2.2 ( $\text{pF}$  or  $\mu F$ ).

MULTIPLIER		TOLERANCE OF CAPACITOR		
FOR THE NUMBER:	MULTIPLY BY:	10 pF OR LESS	LETTER	OVER 10 pF
0	1	$\pm 0.1 \text{ pF}$	B	
1	10	$\pm 0.25 \text{ pF}$	C	
2	100	$\pm 0.5 \text{ pF}$	D	
3	1000	$\pm 1.0 \text{ pF}$	F	$\pm 1\%$
4	10,000	$\pm 2.0 \text{ pF}$	G	$\pm 2\%$
5	100,000		H	$\pm 3\%$
			J	$\pm 5\%$
8	0.01		K	$\pm 10\%$
9	0.1		M	$\pm 20\%$

\*DuPont Registered Trademark.



## PARTS LIST

Unpack the kit and check each part against the following list. The key numbers correspond to the numbers on the "Parts Pictorial." Do not remove components from the tape until you use them in a step. If a part is packed in an individual envelope with the part number on it, identify the part; then return it to the envelope until a step calls for it. Do not throw away any packing material until you account for all of the parts.

To order a replacement part, always include the PART NUMBER. Use the Parts Order Form furnished with this kit. If a Parts Order Form is not available, refer to "Replacement Parts" inside the rear cover of this Manual. For prices, refer to the separate "Heath Parts Price List."

KEY No.	HEATH Part No.	QTY.	DESCRIPTION
---------	----------------	------	-------------

### CAPACITORS

#### Ceramic

← A1	21-701	1	3.3 pF
← A1	21-757	2	22 pF
← A1	21-6	1	27 pF
← A1	21-7	1	33 pF
← A1	21-147	1	47 pF
← A1	21-738	3	68 pF (680)
← A1	21-75	3	100 pF (100K)
← A1	21-171	1	680 pF
← A1	21-163	1	.001 μF (1000 pF)
← A1	21-176	15	.01 μF

### ELECTROLYTIC

← A2	25-879	1	4.7 μF
← A2	25-880	4	10 μF
← A2	25-928	2	33 μF
← A2	25-883	2	47 μF
← A2	25-948	2	100 μF
← A2	25-887	2	220 μF

CIRCUIT Comp. No.
-------------------

C345\*\*  
C341\*\*,  
C342\*\*  
Coupling  
C338\*\*  
C342\*  
C328, C329,  
C336\*\*  
C341\*, C345\*,  
coupling  
C344\*  
C336\*, C337\*\*  
C301, C303,  
C305, C306,  
C307, C309,  
C311, C314,  
C315, C317,  
C318, C332,  
C333, C337\*,  
C346

C326  
C302, C304,  
C324, C352  
C321, C335  
C347, C348  
C353, C356  
C354, C355

KEY No.	HEATH Part No.	QTY.	DESCRIPTION	CIRCUIT Comp. No.
---------	----------------	------	-------------	-------------------

### TRANSFORMERS—CRYSTALS—FILTER

← B1	52-197	1	3.395 MHz transformer (may be marked 21167)	T301*
← B1	52-198	1	8.830 MHz transformer (may be marked 18379)	T301**
← B2	404-695	1	455 kHz crystal filter	FL301
← B3	404-696	1	3.395 MHz crystal	Y301*
← B3	404-697	1	8.830 MHz crystal	Y301**

### HARDWARE

← C1	250-1307	2	#6 x 1/4" sheet metal screw
← C2	250-1325	4	6-32 x 1/4" screw
← C3	254-14	1	1/4" lockwasher

### WIRE—CABLE

←	340-9	2"	Bare wire
←	343-12	4'	Shielded cable
←	344-59	15"	White solid wire
←	347-55	9-1/2"	8-wire flat cable

\* Used for 3.395 MHz IF.

\*\* Used for 8.830 MHz IF.

KEY No.	HEATH Part No.	QTY.	DESCRIPTION	CIRCUIT Comp. No.
---------	----------------	------	-------------	-------------------

**TRANSISTORS—INTEGRATED CIRCUIT (IC)**

NOTES:

1. Transistors and integrated circuits may be marked for identification in any of the following four ways:

- A. Part number.
- B. Type number. (For integrated circuits, this refers only to the numbers and letters shown in **bold** print in the Parts List. Disregard any other numbers or letters on the IC.)
- C. Part number and type number.
- D. Part number with a type number other than the one listed.

2. Some transistors and integrated circuits may be packed in conductive material. Do not remove these transistors or ICs from the conductive material until a step directs you to install them.

←D1	417-863	1	MFE131 transistor	Q301
←D2	417-801	8	MPSA20 transistor	Q303, Q304, Q305, Q306, Q307, Q308, Q309, Q310
←D2	417-169	2	MPF105 transistor	Q302, Q311
←D3	442-22	1	N741V IC	U301

KEY No.	HEATH Part No.	QTY.	DESCRIPTION	CIRCUIT Comp. No.
---------	----------------	------	-------------	-------------------

**CONNECTORS—SOCKETS—PLUGS**

←E1	432-120	3	PCB socket	
←E2	432-866	10	Spring connector	
←E3	432-958	1	10-pin socket shell	P301
←E4	432-984	1	10-pin right angle plug	
←E5	434-230	1	8-pin IC socket	
←E6	434-378	1	Phono socket	J1
←E7	438-46	1	Phono plug	

**MISCELLANEOUS**

←F1	6-271-1	1	<i>150 2W</i> 270 Ω, 1-watt (red-violet-brown) resistor	R368
←F2	10-1138	1	10 kΩ control	R348
←F2	10-1142	1	100 kΩ control	R356
←F2	10-1185	1	200 kΩ control	R366
←F3	31-57	1	2.7 to 20 pF trimmer capacitor	C339
←F4	56-674	1	MV209 varactor diode	D312
←	85-3068-2	1	Circuit board	
←F5	204-2891	1	Mounting bracket	
←F6	490-205	1	Pin insertion tool	
←F7		1	Blue and white label*	
←	597-260	1	Parts Order Form*	
←		1	Manual (See Page 1 for the part number.)	
←			Solder	

\* These parts may be packed inside the Manual.

### TAPED COMPONENT CHART

NOTE: The remaining parts are supplied taped on strips. Since these parts are taped in the order of assembly, it is not necessary to check them against the following list.

HEATH Part No.	QTY.	DESCRIPTION	CIRCUIT Comp. No.	HEATH Part No.	QTY.	DESCRIPTION	CIRCUIT Comp. No.
<b>RESISTORS</b>				<b>CAPACITORS</b>			
NOTE: The following resistors are rated at 1/4-watt and have a tolerance of 5% unless otherwise listed. A 5% tolerance is indicated by a fourth color band of gold.				-21-763      1    330 pF (331) axial-lead ceramic      C331			
-6-151-12	2	150 Ω (brn-grn-brn)	R318, R333	-21-761	8	.01 μF (103) axial-lead ceramic	C308, C312, C313, C316, C319, C322, C349, C351
-6-181-12	2	180 Ω (brn-gry-brn)	R303, R341	-21-786	4	.1 μF (104) axial-lead ceramic	C323, C325, C327, C343
-6-221-12	2	220 Ω (red-red-brn)	R306, R354	<b>CHOKES</b>			
-6-561-12	1	560 Ω (grn-blu-brn)	R322	-45-625	1	4.7 μH (yel-viol-gold)	L303**
-6-102-12	5	1000 Ω (brn-blk-red)	R312, R317, R326, R331, R349	-45-631	1	22 μH (red-red-blk)	L303*
-6-152-12	3	1500 Ω (brn-grn-red)	R314, R319, R328	-45-635	2	1 mH (brn-blk-red)	L301, L304
-6-182-12	1	1800 Ω (brn-gry-red)	R305	-45-643	1	330 mH (org-org-blk)	L302
-6-222-12	3	2200 Ω (red-red-red)	R302, R336, R346	<b>DIODES</b>			
-6-272-12	2	2700 Ω (red-viol-red)	R308, R323	-56-56	8	1N4149	D301, D302, D303, D304, D305, D306, D307, D308
-6-332-12	1	3300 Ω (org-org-red)	R334	-56-58	1	1N5234B	D311
-6-472-12	6	4700 Ω (yel-viol-red)	R311, R316, R325, R332, R339, R345	-56-57	2	1N5242B	D313, D314
-6-562-12	2	5600 Ω (grn-blu-red)	R304, R347	-56-655	2	1N6263	D309, D310
-6-822-12	6	8200 Ω (gry-red-red)	R309, R315, R324, R329, R338, R361, R365	* Used for 3.395 MHz IF.			
-6-103-12	2	10 kΩ (brn-blk-org)	R335, R367	** Used for 8.830 MHz IF.			
-6-223-12	1	22 kΩ (red-red-org)	R352				
-6-333-12	5	33 kΩ (org-org-org)	R307, R313, R321, R327, R359				
-6-473-12	2	47 kΩ (yel-viol-org)	R343, R344				
-6-683-12	4	68 kΩ (blu-gry-org)	R337, R355, R357, R358				
-6-104-12	2	100 kΩ (brn-blk-yel)	R301, R351				
-6-124-12	2	120 kΩ (brn-red-yel)	R364, optional				
-6-224-12	2	220 kΩ (red-red-yel)	R362, R363				
-6-824-12	1	820 kΩ (gry-red-yel)	R365				
-6-105-12	2	1 MΩ (brn-blk-grn)	R342, R353				



## STEP-BY-STEP ASSEMBLY

### CIRCUIT BOARD ASSEMBLY

Refer to Pictorial 1-1 as you read the following notes and steps.

#### NOTES:

1. Many circuit board drawings, such as the one shown in Pictorial 1-1, are divided into two or more sections. These sections show you which area of the circuit board you are working in for a specific series of steps.
2. Cut the "Taped Component Chart" from the last page of the Illustration Booklet. Make sure you read the instructions at the top of the chart before you use it. Note that it is divided into numbered sections which correspond to the numbered sections on the circuit board pictorial. The components are listed in the order of assembly.
3. Each series of steps has you installing parts in a top-to-bottom, left-to-right sequence. Occasionally, you may be directed to install a particular component in an area out of sequence. These components are each identified in the step and on the Pictorial with a special callout.
4. As you perform each step, check it off in the box provided. You may also wish to place a check mark near each component on the Pictorial as you install the part.
5. In general, solder instructions are given only at the end of a series of similar steps; you may solder more often if you wish.

In the following steps, you will be given detailed instructions on how to install and solder the first part on the circuit board. Read and perform each step carefully. Then use the same procedure as you install the remaining parts on the board.

Note that the circuit board has foil patterns on one side and outlines of the components (parts) on the other side. The side with the component outlines is referred to as the "component side."

#### Section 1

- (✓) Position the circuit board on your work area in front of you with the component side up as shown in the Pictorial. NOTE: Always install parts on the component side of the circuit board and solder the leads or wires to the circuit board foil pads on the other side, unless a step specifically directs you to do otherwise.
- (✓) Cut the first part, a 220  $\Omega$  (red-red-brn) resistor, from the Taped Component Chart as outlined in the Chart instructions. Bend the resistor leads as shown to fit the hole spacing at R354 on the circuit board.

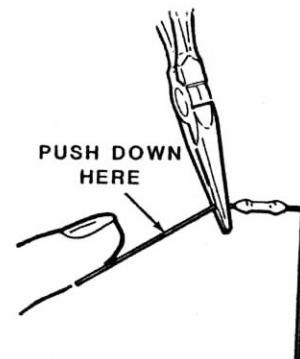

# Heathkit®

- (✓) R354: Start the leads into the holes at the resistor's location in Section 1 of the circuit board. The end with the color bands may be positioned either way. NOTE: Resistors are identified on the circuit board by the following outlines:

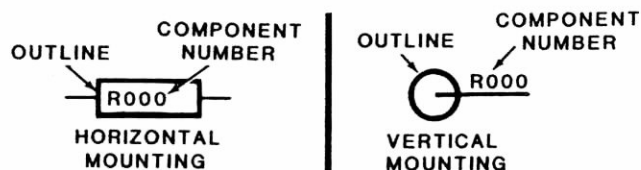

- (✓) Press the resistor against the circuit board. Then bend the leads outward slightly to hold it in place.



- (✓) Solder the resistor leads to the circuit board as follows:

1. Push the soldering iron tip against both the lead and the circuit board foil. Heat **both** for two or three seconds.

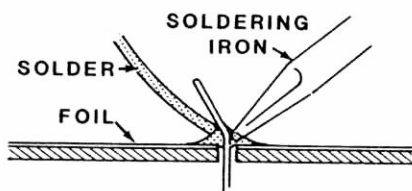

2. Apply solder to the other side of the connection. IMPORTANT: Let the heated lead and the circuit board melt the solder.

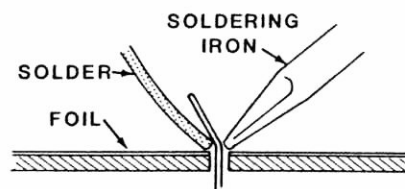

3. As the solder begins to melt, allow it to flow around the connection. Then remove the solder and the iron and let the connection cool.

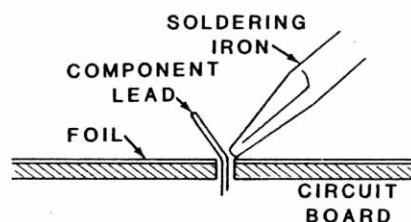

- (✓) Cut off the excess lead lengths close to the connection. WARNING: Clip the leads so the ends will not fly toward your eyes.

- (✓) Check the connection. Compare it to the illustrations in Detail 1-1A. After you have checked the solder connections, proceed with the assembly on Page 12. Use the same soldering procedure for each connection.

NOTES:

1. In some of the following steps, you will install diodes. Whenever you install a diode, always match the banded end with the band mark on the circuit board. A diode will not work properly if it is installed backwards.
2. The banded end of diodes will always be positioned toward the colored tape on the "Taped Component Chart."

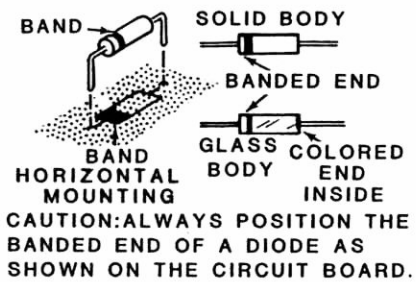
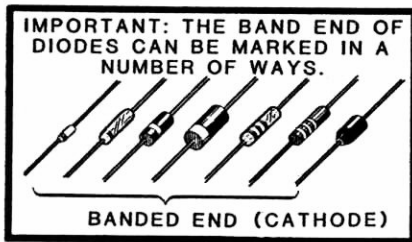

- (✓) D314: 1N5242B diode (#56-57). NOTE: Diodes are identified on the circuit board by the following outline:



- (✓) R357: 68 kΩ (blu-gry-org) resistor.
- (✓) C349: .01 μF (103) axial-lead ceramic capacitor. NOTE: Axial-lead ceramic capacitors are identified on the circuit board by the following outline:

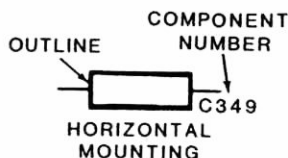

- (✓) R359: 33 kΩ (org-org-org) resistor.
- (✓) R363: 220 kΩ (red-red-yel) resistor.
- (✓) R364: 120 kΩ (brn-red-yel) resistor.
- (✓) R337: 68 kΩ (blu-gry-org) resistor.
- (✓) Solder the leads to the foil and cut off the excess lead lengths.

Section 2

- (✓) L301: 1 mH choke (brn-blk-red, #45-635).
- (✓) L304: 1 mH choke (brn-blk-red, #45-635).
- (✓) R353: 1 MΩ (brn-blk-grn) resistor.
- (✓) C343: .1 μF (104) axial-lead ceramic capacitor.
- (✓) R351: 100 kΩ (brn-blk-yel) resistor.
- (✓) R352: 22 kΩ (red-red-org) resistor.
- (✓) C351: .01 μF (103) axial-lead ceramic capacitor.
- (✓) R355: 68 kΩ (blu-gry-org) resistor.
- (✓) R365: 820 kΩ (gry-red-yel) resistor.
- (✓) Solder the leads to the foil and cut off the excess lead lengths.

Section 3

- (✓) R302: 2200 Ω (red-red-red) resistor.
- (✓) R301: 100 kΩ (brn-blk-yel) resistor.
- (✓) R345: 4700 Ω (yel-viol-red) resistor.
- (✓) C331: 330 pF (331) axial-lead ceramic capacitor.
- (✓) R304: 5600 Ω (grn-blu-red) resistor.
- (✓) R344: 47 kΩ (yel-viol-org) resistor.



# Heathkit®

(✓) R306: 220  $\Omega$  (red-red-brn) resistor.

(✓) R307: 33 k $\Omega$  (org-org-org) resistor.

(✓) R308: 2700  $\Omega$  (red-viol-red) resistor.

(✓) R311: 4700  $\Omega$  (yel-viol-red) resistor.

NOTE: When you install a diode, be sure to match the band on the diode with the outline of the band.

(✓) D302: 1N4149 diode (#56-56).

(✓) D301: 1N4149 diode (#56-56).

(✓) R314: 1500  $\Omega$  (brn-grn-red) resistor.

(✓) R313: 33 k $\Omega$  (org-org-org) resistor.

(✓) R316: 4700  $\Omega$  (yel-viol-red) resistor.

(✓) D304: 1N4149 diode (#56-56).

(✓) D303: 1N4149 diode (#56-56).

(✓) R323: 2700  $\Omega$  (red-viol-red) resistor.

(✓) R321: 33 k $\Omega$  (org-org-org) resistor.

(✓) R325: 4700  $\Omega$  (yel-viol-red) resistor.

(✓) D306: 1N4149 diode (#56-56).

(✓) D305: 1N4149 diode (#56-56).

(✓) R328: 1500  $\Omega$  (brn-grn-red) resistor.

(✓) R327: 33 k $\Omega$  (org-org-org) resistor.

(✓) R332: 4700  $\Omega$  (yel-viol-red) resistor.

(✓) D308: 1N4149 diode (#56-56).

(✓) D307: 1N4149 diode (#56-56).

(✓) Solder the leads to the foil and cut off the excess lead lengths.

## Section 4

(✓) R303: 180  $\Omega$  (brn-gry-brn) resistor.

(✓) C334: DO NOT install a capacitor at this location.

(✓) R343: 47 k $\Omega$  (yel-viol-org) resistor.

(✓) R346: 2200  $\Omega$  (red-red-red) resistor.

(✓) R309: 8200  $\Omega$  (gry-red-red) resistor.

(✓) R312: 1000  $\Omega$  (brn-blk-red) resistor.

(✓) R315: 8200  $\Omega$  (gry-red-red) resistor.

(✓) C312: .01  $\mu$ F (103) axial-lead ceramic capacitor.

(✓) R317: 1000  $\Omega$  (brn-blk-red) resistor.

(✓) R318: 150  $\Omega$  (brn-grn-brn) resistor.

(✓) R322: 560  $\Omega$  (grn-blu-brn) resistor.

(✓) R324: 8200  $\Omega$  (gry-red-red) resistor.

(✓) R326: 1000  $\Omega$  (brn-blk-red) resistor.

(✓) R333: 150  $\Omega$  (brn-grn-brn) resistor.

(✓) Solder the leads to the foil and cut off the excess lead lengths.

Refer to Pictorial 1-2 for the following steps.

NOTE: Mount the following components vertically as shown below:



## Section 1

- (✓) R367: 10 k $\Omega$  (brn-blk-org) resistor.
- (✓) D313: 1N5242B diode (#56-57). Be sure to mount this diode over its outline with the band up as shown below.

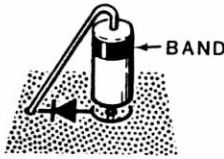

- (✓) R358: 68 k $\Omega$  (blu-gry-org) resistor.
- (✓) R341: 180  $\Omega$  (brn-gry-brn) resistor.
- (✓) C327: .1  $\mu$ F (104) axial-lead ceramic capacitor.
- (✓) R338: 8200  $\Omega$  (gry-red-red) resistor.
- (✓) C325: .1  $\mu$ F (104) axial-lead ceramic capacitor.
- (✓) R336: 2200  $\Omega$  (red-red-red) resistor.
- (✓) Solder the leads to the foil and cut off the excess lead lengths.

## Section 2

- (✓) R347: 5600  $\Omega$  (grn-blu-red) resistor.
- (✓) D311: 1N5234B diode (#56-58). Be sure to mount this diode over its outline with the band up.
- (✓) R349: 1000  $\Omega$  (brn-blk-red) resistor.
- (✓) R361: 8200  $\Omega$  (gry-red-red) resistor.
- (✓) R339: 4700  $\Omega$  (yel-viol-red) resistor.
- (✓) R362: 220 k $\Omega$  (red-red-yel) resistor.
- (✓) R335: 10 k $\Omega$  (brn-blk-org) resistor.
- (✓) C323: .1  $\mu$ F (104) axial-lead ceramic capacitor.

- (✓) D310: 1N6263 diode (#56-655). Be sure to mount this diode over its outline with the band up.
- (✓) D309: 1N6263 diode (#56-655). Be sure to mount this diode over its outline with the band up.
- (✓) C322: .01  $\mu$ F (103) axial-lead ceramic capacitor.
- (✓) R334: 3300  $\Omega$  (org-org-red) resistor.
- (✓) Solder the leads to the foil and cut off the excess lead lengths.

## Section 3

- (✓) R342: 1 M $\Omega$  (brn-blk-grn) resistor.

NOTE: This Pan Adaptor Module may be built to operate with a receiver that has a 3.395 MHz IF or an 8.830 MHz IF amplifier.

- (✓) Refer to the list of IF frequencies supplied with this kit or your receiver manual and determine which frequency your receiver uses for its IF amplifier. Then write this frequency on the following line. 8.830  
KENWOOD TS 440-S

NOTE: In many of the following steps, you will be given a choice of values instead of a specific value. Always use the value that corresponds to the frequency that you wrote on the line in the above step.

- (✓) L303: Choke. NOTE: Both of the following chokes are taped on the strip. Cut the one that you do not use from the strip and set it aside. It will not be used.

3.395 MHz IF: 22  $\mu$ H (red-red-blk, #45-631)

OR

—8.830 MHz IF: 4.7  $\mu$ H (yel-viol-gold, #45-625)

- (✓) L302: 330 mH choke (org-org-blk, #45-643).
- (✓) Solder the leads to the foil and cut off the excess lead lengths.

## Section 4

- (✓) R305: 1800  $\Omega$  (brn-gry-red) resistor.
- (✓) C308: .01  $\mu\text{F}$  (103) axial-lead ceramic capacitor.
- (✓) C313: .01  $\mu\text{F}$  (103) axial-lead ceramic capacitor.
- (✓) R319: 1500  $\Omega$  (brn-grn-red) resistor.
- (✓) C316: .01  $\mu\text{F}$  (103) axial-lead ceramic capacitor.
- (✓) R329: 8200  $\Omega$  (gry-red-red) resistor.
- (✓) C319: .01  $\mu\text{F}$  (103) axial-lead ceramic capacitor.
- (✓) R331: 1000  $\Omega$  (brn-blk-red) resistor.
- (✓) Solder the leads to the foil and cut off the excess lead lengths.
- (✓) Cut the remaining 120 k $\Omega$  (brn-red-yl) resistor from the "Taped Component Chart." Then set it aside for possible use later.

Refer to Pictorial 1-3 for the following steps.

NOTE: The following parts are not taped on strips.

## Section 1

- (✓) P301: 10-pin right angle plug. Start the shorter pins into the circuit board holes as shown below so the longer pins are toward the nearby edge of the circuit board. Then push the plug down tight against the circuit board and solder the pins to the foil.

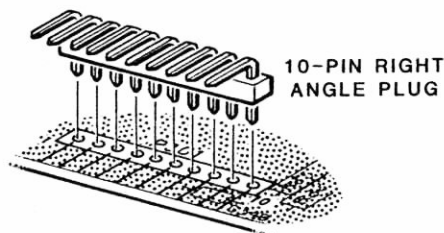

## Section 2

NOTE: When a step directs you to prepare a solid wire, as in the next step, first cut the wire to the indicated length. Then remove 1/4" of insulation from each end.

- (✓) W305: Prepare a 1-1/8" white solid wire. Then install and solder the wire in the circuit board at W305. NOTE: Wires are indicated on the circuit board by the following outline:

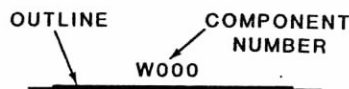

- (✓) R348: 10 k $\Omega$  control (#10-1138). Match the shape of the control with the outline on the circuit board and start the leads into their corresponding circuit board holes. Then push the control down tight against the board and solder the leads to the foil. Cut off any excess lead lengths.

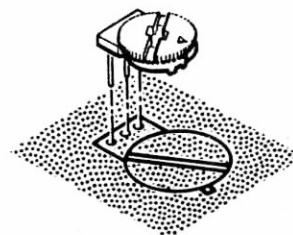

- (✓) R356: 100 k $\Omega$  control (#10-1142). Solder the leads to the foil and cut off any excess lead lengths.

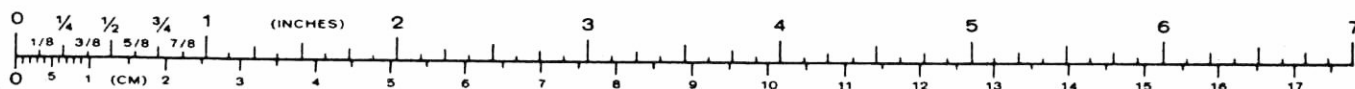



- (✓) 8-pin IC socket at U301. Make sure the pins are straight. If there is any kind of identification mark (notch, dot, arrowhead, etc.) at or near one end of the socket, place this marked end toward the index mark on the circuit board (this index mark should still be visible after you install the socket). Then start the pins into the circuit board holes and solder them to the foil.

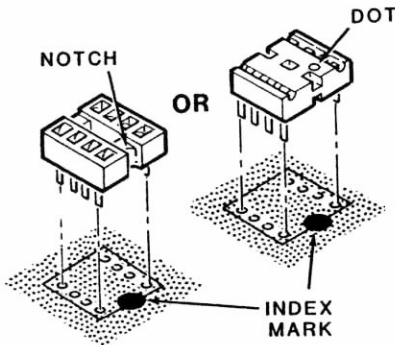

- (✓) W306: Prepare a 1" white solid wire. Then install the wire in the circuit board at W306.
- (✓) Solder the leads to the foil and cut off the excess lead lengths.

**Section 3**

- (✓) W302: Prepare a 3/4" white solid wire. Then install the wire in the circuit board at W302.
- (✓) C339: 2.7 to 20 pF trimmer capacitor. Match the shape of the trimmer with the outline on the circuit board and start the lugs into their corresponding circuit board holes. Push the trimmer down tight against the circuit board and solder the lugs to the foil.



- (✓) R366: 200 kΩ control (#10-1185). Solder the leads to the foil and cut off any excess lead lengths.
- (✓) Prepare two 1" white solid wires. Use these wires in the next two steps.
- (✓) W304: 1" white solid wire.
- (✓) W303: 1" white solid wire.
- (✓) Solder the leads to the foil and cut off the excess lead lengths.

**Section 4**

NOTE: Perform the next step **only** if you are assembling your Pan Adaptor Module to work with a 3.395 MHz IF. If you are assembling your Pan Adaptor Module to work with an 8.830 MHz IF, skip the step and proceed directly to "Section 1" which follows (do not install a wire at W301 or C334).

- (✓) *SKIP* Prepare a 1-1/4" white solid wire. Then refer to the inset drawing and use the following procedure to install the wire:

1. Refer to Part A of the Detail and solder one end of the wire in the indicated hole for W301.
2. Refer again to Part A of the Detail and solder the other end of the wire in the indicated hole for C334.
3. Cut the wire in the center of the loop. Do not remove any insulation from the ends.
4. Refer to Part B of the Detail and form the ends of the wire down against the circuit board as shown. NOTE: These wires form a "gimmick" capacitor.

Refer to Pictorial 1-4 for the following steps.

**Section 1**

- (✓) *150 2w* R368: 270 Ω, 1-watt (red-viol-brn) resistor. Solder the leads to the foil and cut off the excess lead lengths.

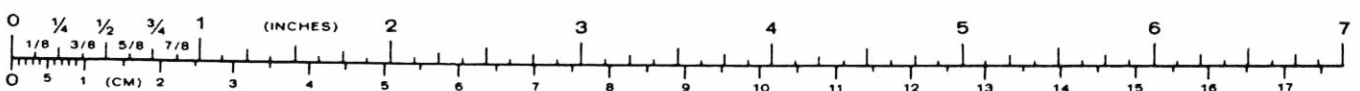

# Heathkit®

## Section 2

### NOTES:

- In the following steps, you will install disc-type ceramic capacitors. When you install these capacitors, do not push the insulated portion of the leads into the circuit board holes. This could make it difficult to solder the leads to the foil.

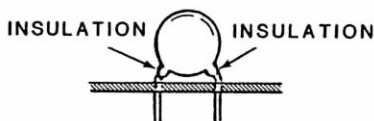

- Ceramic capacitors are identified on the circuit board by the following outline:

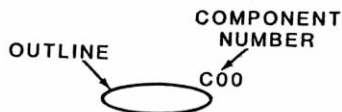

- Make sure in each step that you install the correct capacitor that matches the IF frequency of your receiver or transceiver.

(✓) C344: Ceramic capacitor.

3.395 MHz IF: 680 pF

OR

→ 8.830 MHz IF: None

(✓) C345: Ceramic capacitor. Use the holes that best fit the capacitor supplied with your kit.

3.395 MHz IF: 100 pF (100 K)

OR

→ 8.830 MHz IF: 3.3 pF

(✓) C342: Ceramic capacitor.

3.395 MHz IF: 47 pF

OR

→ 8.830 MHz IF: 22 pF

(✓) C341: Ceramic capacitor.

3.395 MHz IF: 100 pF (100K)

OR

→ 8.830 MHz IF: 22 pF

(✓) C338: Ceramic capacitor.

3.395 MHz IF: None

OR

→ 8.830 MHz IF: 33 pF

(✓) C336: Ceramic capacitor. Use the holes that best fit the capacitor supplied with your kit.

3.395 MHz IF: .001  $\mu$ F (1000 pF)

OR

→ 8.830 MHz IF: 68 pF (680)

(✓) C337: Ceramic capacitor.

3.395 MHz IF: .01  $\mu$ F

OR

→ 8.830 MHz IF: .001  $\mu$ F (1000 pF)

(✓) C305: .01  $\mu$ F ceramic capacitor.

(✓) C346: .01  $\mu$ F ceramic capacitor.

(✓) C311: .01  $\mu$ F ceramic capacitor.

(✓) C314: .01  $\mu$ F ceramic capacitor.

(✓) Solder the leads to the foil and cut off the excess lead lengths.

## Section 3

(✓) C303: .01  $\mu$ F ceramic capacitor.

(✓) C301: .01  $\mu$ F ceramic capacitor.

(✓) C329: 68 pF (680) ceramic capacitor.

(✓) C328: 68 pF (680) ceramic capacitor.

Install .01  $\mu$ F ceramic capacitors at the following eight locations:

(✓) C333.

(✓) C306.

(✓) C332.

(✓) C307.

(✓) C309.

- (✓) C315.
- (✓) C317.
- (✓) C318.
- (✓) Solder the leads to the foil and cut off the excess lead lengths.

2. Before you install the IC, lay it down on its side as shown below and very carefully roll it toward the pins to bend the lower pins into line. Then turn the IC over and bend the pins on the other side in the same manner.

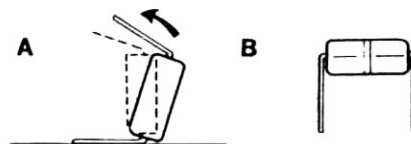

Refer to Pictorial 1-5 for the following steps.

**Section 1**

**NOTE:** When you install a transistor, position it so the flat side is over the outline of the flat on the circuit board. Then start the leads into their corresponding holes, position the transistor 1/4" above the circuit board, and solder the leads to the foil. Cut off any excess lead lengths.

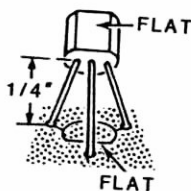

3. Compare the IC to the drawing shown below. Then determine which end of the IC is the pin 1 end.

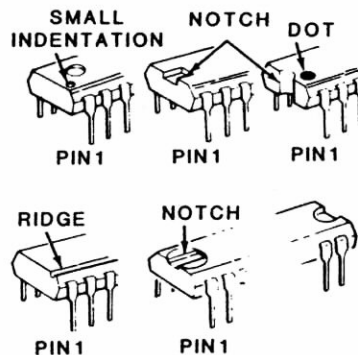

- (✓) Q309: MPSA20 transistor (#417-801).
- (✓) U301: Use the following procedure to install an N741V integrated circuit (#442-22) in the socket at U301:

1. The pins on the IC may be bent out at an angle, so they do not line up with the holes in the IC socket. DO NOT try to install an IC without first bending the pins as described below. To do so may damage the IC pins or the socket, causing intermittent contact.

4. Position the pin 1 end of the IC over the index mark on the circuit board and start the IC pins into the socket. Make sure all of the pins are correctly started. Then push the IC firmly into the socket. **NOTE:** An IC pin can become bent under the IC and it will appear as though it is correctly installed in the socket.

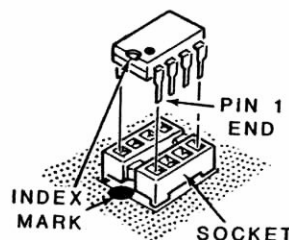

# Heathkit®

## Section 2

NOTE: Solder the following parts to the foil and cut off any excess lead lengths as you install them.

(✓) Q311: MPF105 transistor (#417-169).

(✓) FL301: 455 kHz crystal filter (#404-695). Match the five lugs on the filter with the holes in the circuit board. Then start the lugs into their corresponding holes, push the filter down against the board, and solder the lugs to the foil.

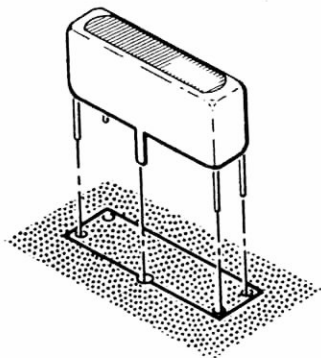

(✓) D312: MV209 varactor diode (#56-674). Use the same procedure to install this diode as you use to install transistors.

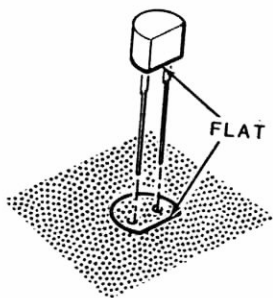

(✓) Q308: MPSA20 transistor (#417-801).

## Section 3

(✓) Q301: MFE131 transistor (#417-863). Use the following procedure to install this transistor, which can be damaged by static electricity:

1. Remove the transistor from its package and do not let go of it until you have it installed in the circuit board.
2. Match the tab on the transistor with the outline of the tab on the circuit board. Then start the leads into their corresponding holes.

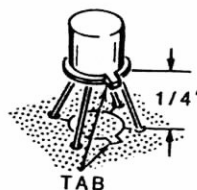

3. Solder the leads to the foil and cut off the excess lead lengths.

(✓) Q310: MPSA20 transistor (#417-801).

(✓) Q302: MPF105 transistor (#417-169).

Install MPSA20 transistors (#417-801) at the following five locations:

(✓) Q303.

(✓) Q304.

(✓) Q305.

(✓) Q306.

(✓) Q307.

**Section 4**

(✓) T301: Transformer.

**3.395 MHz IF:** 3.395 MHz transformer (marked #52-197 or 21167). Be sure to install this transformer so the 3 pins on one side are **toward** the nearby edge of the circuit board.

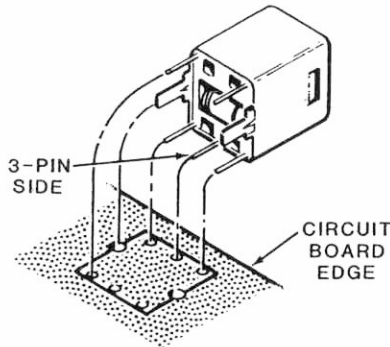

**OR**

➔ **8.830 MHz IF:** 8.830 MHz transformer (marked #52-198 or 18379). Be sure to install this transformer so the 3 pins on one side are **away** from the nearby edge of the circuit board.

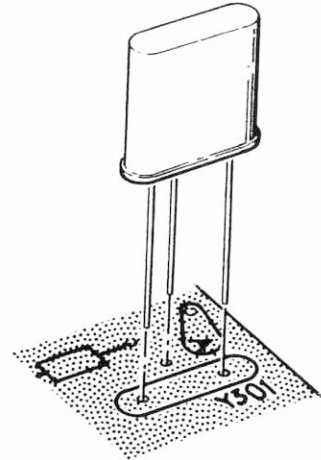
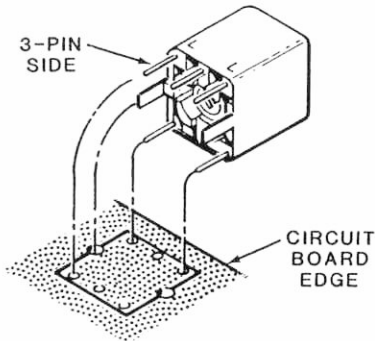

Refer to Pictorial 1-6 for the following steps.

**Section 1**

**NOTE:** Before you install each of the following electrolytic capacitors, look at it and identify the leads. One lead will have a positive (+) mark or a negative (-) mark near it. Be sure to install the positive lead in the positive-marked hole, or the negative lead in the negative-marked hole.

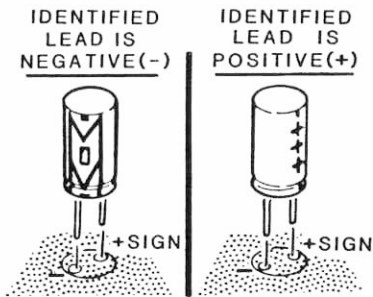

(✓) C354: 220  $\mu$ F electrolytic capacitor. **NOTE:** Electrolytic capacitors are identified on the circuit board by the following outline:



(✓) Y301: Crystal.

**3.395 MHz IF:** 3.395 MHz crystal (#404-696)

**OR**

➔ **8.830 MHz IF:** 8.830 MHz crystal (#404-697)

(✓) C355: 220  $\mu$ F electrolytic capacitor.

(✓) C356: 100  $\mu$ F electrolytic capacitor.



- (✓) C353: 100  $\mu$ F electrolytic capacitor.
- (✓) C326: 4.7  $\mu$ F electrolytic capacitor.
- (✓) C324: 10  $\mu$ F electrolytic capacitor.
- (✓) Solder the leads to the foil and cut off the excess lead lengths.

## Section 2

- (✓) C335: 33  $\mu$ F electrolytic capacitor.
- (✓) C348: 47  $\mu$ F electrolytic capacitor.
- (✓) C347: 47  $\mu$ F electrolytic capacitor.
- (✓) C352: 10  $\mu$ F electrolytic capacitor.
- (✓) Solder the leads to the foil and cut off the excess lead lengths.

## Section 3

- (✓) C302: 10  $\mu$ F electrolytic capacitor.
- (✓) C304: 10  $\mu$ F electrolytic capacitor.
- (✓) C321: 33  $\mu$ F electrolytic capacitor.
- (✓) Solder the leads to the foil and cut off the excess lead lengths.
- (✓) Prepare a 5" and a 3-1/4" white solid wire. Use these wires in the next two steps.
- (✓) Connect the prepared 5" wire between the two holes labeled B as shown. Be sure to route the wire exactly as shown in the Pictorial. Solder the wire to the foil and cut off any excess wire ends.
- (✓) Connect one end of the prepared 3-1/4" wire to hole A. Solder the wire to the foil and cut off any excess wire end. NOTE: The other end of this wire will be connected later.

## CIRCUIT BOARD CHECKOUT

Carefully inspect the foil side of the circuit board for the following most-commonly-made errors:

- (✓) Unsoldered connections.
- (✓) Poor solder connections.
- (✓) Solder bridges between foil patterns.
- (✓) Protruding leads which could touch together or the mounting bracket when the circuit board is mounted later.

Refer to the illustrations where parts are installed as you make the following visual checks:

- (✓) Diodes for the proper **type** and **installation**.
- (✓) Transistors for the proper **type** and **installation**.
- (✓) Electrolytic capacitors for the correct position of the positive (+) or negative (-) marked lead.
- (✓) Integrated circuit for the proper installation.

## NOTES:

1. If you assembled the Pan Adaptor Module to work with a 3.395 MHz IF, you will have the following parts left over:

3.3 pF ceramic capacitor  
 22 pF ceramic capacitor  
 27 pF ceramic capacitor  
 33 pF ceramic capacitor  
 68 pF ceramic capacitor  
 100 pF ceramic capacitor  
 4.7  $\mu$ H (yel-viol-gold) choke  
 8.830 MHz crystal (#404-697)  
 8.830 MHz transformer (marked #52-198 or 18379)  
 120 k $\Omega$  (brn-red-yel) resistor



2. If you assembled the Pan Adaptor Module to work with an 8.830 MHz IF, you will have the following parts left over:

- ✓ one 27 pF ceramic capacitor
- ✓ one 47 pF ceramic capacitor
- ✓ three 100 pF ceramic capacitor
- ✓ one 680 pF ceramic capacitor
- ✓ one .01  $\mu$ F ceramic capacitor
- ✓ one 22  $\mu$ H (red-red-blk) choke
- ✓ one 3.395 MHz crystal (#404-696)
- ✓ one 3.395 MHz transformer (marked #52-297 or 21167)
- ✓ one 120 k $\Omega$  (brn-red-yel) resistor

### INSTALLATION IN STATION MONITOR

- (✓) Unplug the Station Monitor's line cord, if this has not already been done.
- (✓) Remove the ten #6 x 1/4" sheet metal screws that secure the cover on your Station Monitor. Then remove the cover. Set the screws and cover aside temporarily.

Refer to Pictorial 1-7 for the following steps.

- (✓) J1: Refer to Detail 1-7A and mount the phono socket to the mounting bracket at J1. Use the nut supplied with the socket and a 1/4" lock-washer as shown. Discard the flat washer and solder lug supplied with the socket. NOTE: Be sure to position the socket so the lug is up as shown.
- (✓) Bend J1 lug 1 up 90 degrees as shown in the inset drawing on the Pictorial.
- (✓) Position the mounting bracket inside the Station Monitor chassis as shown. Then use two #6 x 1/4" sheet metal screws to secure the bracket to the chassis.
- (✓) Position the circuit board assembly onto the mounting bracket as shown. Then use four 6-32 x 1/4" screws to mount the circuit board to the bracket.

Refer to Pictorial 1-8 for the following steps.

- (✓) Connect and solder the free end of the wire coming from circuit board hole A to J1 lug 1.
- (✓) Cut a 9-3/4" length of 8-wire flat cable. Then refer to Detail 1-8A and use the following procedure to prepare this 9-3/4" length of 8-wire flat cable:
  1. Separate the wires at one end of the cable for a length of 1-1/4".
  2. Place a mark on the gray wire 3/4" away from the end as shown in the inset drawing. Then draw a line from this mark to the end of the brown wire. Now cut along the line as shown so each wire is successively longer as you cut from the gray wire to the brown wire.
  3. Remove 1/8" of insulation from the end of each wire at this end of the cable. Tightly twist together the wires at this end of the cable. Then melt a small amount of solder on these ends to hold the fine strands together. NOTE: This end of the cable will be referred to as "end A."
  4. Separate the brown and red wires at the other end of the cable (as a pair) from the other wires for 6". Then shorten the brown and red wires by 2-1/2". Now separate the brown and red wires from each other for a length of 1-1/4".
  5. Separate the gray wire from the other wires for a length of 4".
  6. Separate the remaining five wires for a length of 1-1/4".
  7. Remove 1/4" of insulation from the end of each wire at this end of the cable. Tightly twist together the wires at this end of the cable. Then melt a small amount of solder on these ends to hold the fine strands together. NOTE: This end of the cable will be referred to as "end B."

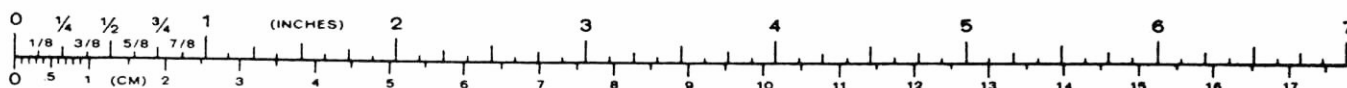

# Heathkit®

- (✓) Refer to Detail 1-8B Part A and install a spring connector on the end of each wire at **end A** of the prepared cable.

Refer to Detail 1-8B Part B and push the spring connectors into the holes of the 10-pin socket shell as follows. NOTE: Be sure to position the spring connectors and the socket shell as shown.

- (✓) Brown wire into hole 1.
- (✓) Red wire into hole 2.
- (✓) Orange wire into hole 3.
- (✓) Yellow wire into hole 4.
- (✓) Green wire into hole 5.
- (✓) Blue wire into hole 6.
- (✓) Violet wire into hole 7.
- (✓) Gray wire into hole 8.
- (✓) Refer to Detail 1-8C and install PCB connectors on the ends of the brown, red, and gray wires at end B of the cable.

- (✓) Cut a 7-3/8" length of shielded cable. Then refer to Detail 1-8D and prepare the ends as shown.

- (✓) Install spring connectors on the end of the inner wire and shield wire at **end A** of the prepared shielded cable.

Push the spring connectors on the shielded cable into the holes of the 10-pin socket shell as follows:

- (✓) Shield wire into hole 9.
- (✓) Inner wire into hole 10.
- (✓) Push the 10-pin socket shell onto pan adaptor circuit board plug P301. Be sure the brown wire is at plug pin 1.

NOTE: In the following steps, "S-" with a number, such as (S-2), means to solder the connection. The number following the "S-" tells you how many wires

should be at the connection. This helps you check your work for errors as you go.

Route the free end of the shielded cable coming from P301 toward the front of the Station Monitor as shown. Then connect the wires at the end of this cable as follows:

- (✓) Inner wire to switch SW6 lug 12 (S-1).
- (✓) Shield wire to switch SW4 lug 6 (S-2). NOTE: A black wire was previously connected to this lug.

Route the free end (end B) of the 8-wire flat cable coming from P301 toward the front of the Station Monitor as shown. Then connect the wires on the ends of this cable as follows:

- (✓) Yellow wire to switch SW8 lug 3 (S-1).
- (✓) Orange wire to switch SW8 lug 2 (S-1).
- (✓) Blue wire to switch SW7 lug 3 (S-1).
- (✓) Green wire to switch SW7 lug 2 (S-1).
- (✓) Violet wire to switch SW7 lug 1 (S-1).
- (✓) Loop the gray wire around the shielded cable as shown. Then push the PCB connector on the end of the wire onto main circuit board pin P1.
- (✓) Push the PCB connector on the free end of the brown wire onto main circuit board pin P3.
- (✓) Push the PCB connector on the free end of the red wire onto main circuit board pin P4.
- (✓) Carefully peel the backing paper from the blue and white label. Then press the label onto the bottom of the chassis. Be sure to refer to the numbers on this label in any communications you may have with the Heath Company about your kit.

NOTE: The cover will be reinstalled on the Station Monitor during the "Tests and Adjustments."

This completes the assembly and installation of the Pan Adaptor in your Station Monitor. Proceed to "Tests and Adjustments."

## TESTS AND ADJUSTMENTS

NOTE: You will need a VTVM or volt-ohmmeter to perform the following "Tests and Adjustments." The indications you obtain in the following steps may vary slightly, depending upon the type of meter you use.

### INITIAL TESTS

Refer to Pictorial 2-1 for the following steps.

- (✓) Release all of the front panel pushbutton switches to their out positions, if this has not already been done. Leave these switches in their released positions until you are directed to depress them.
- (✓) Connect the common ohmmeter lead to the mounting bracket. Leave this lead connected to the bracket until a step directs you to disconnect it.

NOTE: If you do not obtain the correct indications in the following steps, check the pan adaptor circuit board for solder bridges. Also check your wiring between the pan adaptor circuit board and the Station Monitor. Refer to the "In Case of Difficulty" section if you are still not able to resolve the problem.

Touch the positive ohmmeter probe to the pins of plug P301 as follows and check for the proper indications.

(✓) Set your ohmmeter to the  $R \times 100$  range.

478 (✓) Pin 1, 550 to 700  $\Omega$ .

(✓) Set your ohmmeter to the  $R \times 1000$  range.

(✓) Pin 2, greater than 1500  $\Omega$ .

(✓) Set your ohmmeter to the  $R \times 100$  range.

(✓) Pin 3, 550 to 700  $\Omega$ .

(✓) Set your ohmmeter to the  $R \times 1000$  range.

(✓) Pin 4, greater than 40 k $\Omega$ .

(✓) Pin 5, greater than 10 k $\Omega$ .

(✓) Pin 6, greater than 20 k $\Omega$ .

(✓) Pin 7, greater than 15 k $\Omega$ .

(✓) Pin 8, 100 k $\Omega$ .

(✓) Pin 9, zero ohms.

(✓) Pin 10, infinity.

### ADJUSTMENTS

(✓) Refer to Detail 2-1A and use the following procedure to prepare an alignment tool:

1. Sharply bend over one end of the large bare wire for 1/4" as shown.
2. Push the bent end of the bare wire as far as possible into the pin insert.
3. Use long-nose pliers to flatten the exposed end of the bare wire. Be sure the end of the wire is square (like a screwdriver blade). If necessary, cut off a small amount so the end is square. NOTE: Use this tool to make adjustments in the following steps.

(✓) Preset trimmer capacitor C339 on the Pan Adaptor circuit board to mid capacity as shown in inset drawing #1 on the Pictorial.

(✓) Preset controls R348, R356, and R366 on the Pan Adaptor circuit board to their centers of rotation.

NOTE: Use caution when you perform the following steps. Hazardous voltages are present at several points on the main circuit board.

- (✓) 1. Depress the SSB, RTTY, and 100 Hz pushbuttons on the front of the Station Monitor. NOTE: You will have to press the SSB and RTTY pushbuttons at the same time so they will stay depressed.
- (✓) 2. Set the SWEEP and VERTICAL GAIN controls to the centers of their rotation.

# Heathkit®

- (✓) 3. Plug in the line cord.
- (✓) 4. Depress the POWER pushbutton.
- (✓) 5. When you obtain a trace on the screen, adjust the HORIZONTAL GAIN control until the line fills the screen and is centered between the left and right sides of the graticule.
- (✓) 6. Use a bare wire or cutoff component lead to temporarily short together plug P301 pins 8 and 9 (gray wire and the shield wire of the shielded cable). See inset drawing #2 on the Pictorial.
- (✓) 7. Connect the common lead of your voltmeter to the pan adaptor mounting bracket, if this has not already been done.
- (✓) 8. Set your DC voltmeter to its lowest range. NOTE: The voltage that you initially obtain in the next step could be positive or negative.
- (✓) 9. Connect the positive voltmeter probe to the indicated lead of resistor R361 (8200  $\Omega$ , gry-red-red).
- (✓) 10. Adjust control R366 for as close to zero volts as possible ( $\pm 0.05$  volts).
- (✓) 11. Disconnect the voltmeter from the Station Monitor.
- (✓) 12. Remove the temporary jumper wire between plug P301 pins 8 and 9.
- (✓) 13. Depress the 20 kHz/100 kHz and MARKER pushbuttons on the front of the Station Monitor. NOTE: These pushbuttons are labeled in orange on the front panel.
- (✓) 14. Adjust trimmer capacitor C339 to position the marker pip in the center of the screen as shown in inset drawing #3 on the Pictorial. After you make this adjustment, note the exact position of the pip. NOTE: The marker may initially be off the screen.

NOTE: If you assembled your Pan Adaptor Module to work with a 3.395 MHz IF, you may find it necessary in the next step to decouple the gimmick capacitor so you can keep the marker pip about 1/2" high. To do this, spread apart the two wires that are located between transformer T301 and crystal Y301.

- (✓) 15. Adjust coil T301 for the highest display possible. Use the VERTICAL GAIN control as necessary to keep the display about 1/2" high.
- (✓) 16. Release the 20 kHz/100 kHz pushbutton. Then adjust control R356 to position the marker at the same point on the screen where it was in step 14. NOTE: The pip may be off the screen when you release this switch.
- (✓) 17. Alternately press and release the 100 kHz and 20 kHz pushbutton. Then adjust controls R348 (at 100 kHz) and R356 (at 20 kHz) so that the pip remains in the center of the screen. NOTE: When you press and release this switch, the display may become offset by a small amount and then drift back to the preset point. This is a normal characteristic caused by the charging effect of a capacitor in the sweep circuit. The display should return to the preset point within about 3 to 5 seconds.
- (✓) 18. Reinstall the cover on the Station Monitor and allow the Monitor to reach its normal operating temperature (approximately 45 minutes) before you perform the next step. Be sure to install the cover so the side with the holes is over the Pan Adaptor Module.

NOTE: While you are waiting for the Station Monitor to warm up, you may wish to read the "Installation" section of this Manual and plan the connections to your transceiver or receiver.

- (✓) 19. Repeat step 17 so the pip remains centered on the screen when you press and release the 20 kHz/100 kHz pushbutton. NOTE: You can access the controls and trimmer capacitor through the slots in the cover as shown in Pictorial 2-2.

This completes the "Tests and Adjustments." Proceed to "Installation."



Pg. 74 Service Man.  
Pg. 38 Inst. Man.

27 pF 4403

**Heathkit®**

## INSTALLATION

For proper operation, the Pan Adaptor Module requires connection to your transceiver or receiver at the output of the receiver mixer, just before the first crystal filter (See Pictorial 3-1 for a partial block diagram of a typical receiver). If your receiver has an IF amplifier between the mixer and crystal filter, be sure to make your connections between the amplifier and the crystal filter as shown. Use as small a coupling capacitor as practical so you do not load or desensitize the IF amplifier. Two capacitors, 27 pF and 100 pF, are supplied with your Pan Adaptor Module for this purpose. These capacitor values may be too high or too low, however, for your particular receiver. Make sensitivity measurements before and after connection to make sure no loading or desensitizing occurs. If a common IF is used for both transmitting and receiving, you can check the transmitter output before and after connection.

The following sections show you how to connect the Pan Adaptor to various pieces of Heath equipment. You can also use the information presented here to make connections to other non-Heath brands of equipment.

### SS-9000 TRANSCEIVER

- ( ) Remove the covers from your Transceiver.

Refer to Pictorial 3-2 for the following steps.

NOTE: Keep the coupling capacitor leads as short as possible in the following steps to help prevent the leads from shorting to other nearby circuit board foils.

- ( ) Tack solder one lead of a 100 pF ceramic capacitor to the indicated foil pattern on the T/R circuit board. NOTE: You will have to temporarily remove a shield to make these connections.

- ( ) Prepare one end of the shielded cable supplied with the Pan Adaptor. Use the same procedure as you did when you installed the Pan Adaptor in your Station Monitor. Then connect the inner lead to the remaining lead of the 100 pF capacitor and the shield wire to the indicated ground foil. NOTE: We recommend that you apply tape to the junction of the capacitor lead and the shielded cable inner lead to prevent the connection from shorting to any nearby foils.
- ( ) Reinstall the shield on the T/R circuit board. Be sure to route the shielded cable out through the indicated notch.
- ( ) Route the shielded cable out through the rear of the Transceiver. NOTE: If you wish, you may route the cable to one of the spare phono sockets on the rear panel.
- ( ) Reinstall the covers on your Transceiver.
- ( ) Refer back to Detail 3-1A and install a phono plug on the free end of the shield of the cable coming from your Transceiver. NOTE: Do not make this cable any longer than necessary.
- ( ) Connect the free end of the shielded cable to the PAN INPUT socket on the rear of the Station Monitor.

Proceed to the "Operation" section.

**HW-5400 TRANSCEIVER**

- ( ) Remove the covers from your Transceiver.

Refer to Pictorial 3-3 for the following steps.

- ( ) Tack solder one lead of a 27 pF ceramic capacitor to the wire that is connected to plug P407 pin 5. NOTE: You can either remove some of the insulation from the wire that is connected to this pin, or you can remove the spring connector from the socket, solder the capacitor lead to the spring connector, and reinstall the spring connector in the socket.
- ( ) Prepare one end of the shielded cable supplied with the Pan Adaptor. Use the same procedure as you did when you installed the Pan Adaptor in your Station Monitor. Then connect the inner lead to the remaining lead of the 27 pF capacitor and the shield wire to the top of the indicated shield.
- ( ) Route the shielded cable out through the rear of the Transceiver.
- ( ) Reinstall the covers on your Transceiver.
- ( ) Refer back to Detail 3-1A and install a phono plug on the free end of the shielded cable coming from your Transceiver. NOTE: Do not make this cable any longer than necessary.
- ( ) Connect the free end of the shielded cable to the PAN INPUT socket on the rear of the Station Monitor.

Proceed to the "Operation" section.

**HW-99, SB-104A & HW-101 TRANSCEIVERS**

Pictorials 3-4, 3-5, and 3-6 show partial schematics of some other recent models of Heath Transceivers. Specific directions are not included in this Manual for these Transceivers. The suggested connection points, however, are shown in the schematic diagrams. Refer to "Other Transceivers and Receivers" for information about preparing the ends of the shielded cable supplied with the Pan Adaptor.

**OTHER TRANSCEIVERS & RECEIVERS**

- ( ) Refer back to Pictorial 3-1 and the manual supplied with your transceiver or receiver to determine the proper connection point as described at the beginning of this section of the Manual.

NOTE: Keep the coupling capacitor leads as short as possible in the following steps to help prevent the leads from shorting to other nearby connections.

Refer to Pictorial 3-7 for the following steps.

- ( ) Tack solder one lead of the coupling capacitor you have selected to the connection point in your transceiver or receiver.
- ( ) Prepare one end of the shielded cable supplied with the Pan Adapter. Use the same procedure as you did when you installed the Pan Adaptor in your Station Monitor. Then connect the inner lead to the remaining lead of the coupling capacitor and the shield wire to some nearby ground point. NOTE: We recommend that you apply tape to the junction of the capacitor lead and the shielded cable inner lead to prevent the connection from shorting to any nearby foils.
- ( ) Route the shielded cable out through the rear of the transceiver or receiver.
- ( ) Refer back to Detail 3-1A and install a phone plug on the free end of the shielded cable. NOTE: Do not make this cable any longer than necessary.
- ( ) Connect the free end of the shielded cable to the PAN INPUT socket on the rear of the Station Monitor.

Proceed to the "Operation" section.

## OPERATION

Refer to Pictorial 4-1 as you read the following paragraphs.

**NOTE: The Pan Adaptor functions are labeled in orange on the front of the Station Monitor.**

To use your Pan Adaptor Module, perform the following steps:

1. Simultaneously depress the SSB and RTTY pushbuttons on the front of the Station Monitor. NOTE: These pushbuttons must both be depressed to turn the Pan Adaptor on.
2. Depress the 100 Hz and POWER pushbuttons.
3. After the Station Monitor warms up, adjust the HORIZONTAL GAIN control to fill the graticule.
4. Depress the MARKER pushbutton to turn the marker on. Then use the VERTICAL POSITION and HORIZONTAL POSITION controls to center the marker on the screen (see Pictorial 4-2).

NOTE: The Pan Adaptor is now ready to use. You can use the 10 kHz pushbutton to select the scan width. Depress the pushbutton for a  $\pm 100$  kHz scan width and release the pushbutton for  $\pm 20$  kHz. As you increase the length of the horizontal trace, the viewable scan width will decrease.

5. Adjust the SWEEP control for the desired display.

NOTE: When you look at the screen, the received frequency is at the center of the screen (or at the point where you positioned the marker). The lower frequencies will be on one side of the marker and the higher frequencies will be on the other side. On the Heath Model HW-5400, for example, the lower frequencies are left of the marker and the higher frequencies are on the right side of the marker. Depending upon the tuning scheme used in your particular receiver, this may be reversed.

6. Use the VERTICAL GAIN control to set the height of the pip. We recommend that you adjust this control so the stronger signals produce about 1" of height. If you overdrive the Station Monitor, you may observe some flat-topping of the displayed signals.

NOTE: When you change the scan width, the display may become offset by a small amount and then drift back to the preset point. This is a normal characteristic caused by the charging effect of a capacitor in the sweep circuit. The display should return to the preset point within about 3 to 5 seconds.

### REVERSING THE SCREEN DISPLAY

When you become familiar with the operation of the Pan Adaptor, you may feel that the screen display works backwards from the way you prefer it. This is caused by many factors, one of which is the tuning scheme used in your particular receiver. Refer to Pictorial 4-3 and perform the following steps to reverse the screen display:

- ( ) Temporarily remove the Pan Adaptor circuit board from the Station Monitor.
- ( ) Position the circuit board as shown in the Pictorial. Note the location of the part number.
- ( ) Use a sharp knife to cut the foil that goes to plug P301 pin 8. Be sure to cut through the entire foil.
- ( ) Cut both leads of a 120 k $\Omega$  (brn-red-yel) resistor to 3/8". Then tack solder the resistor leads to the two indicated foil pads. Make sure the leads do not touch any other connections.
- ( ) Reinstall the circuit board in the Station Monitor.
- ( ) Repeat the "Adjustments" on Pages 24 and 25.

1-386  
7043

## IN CASE OF DIFFICULTY

Begin your search for any trouble that occurs after assembly by carefully following the steps listed below in the "Visual Checks." After you complete the "Visual Checks," refer to the "Troubleshooting Chart."

NOTE: Refer to the "Circuit Board X-Ray View" (Page 48) for the physical location of parts on the circuit board.

### Visual Checks

1. Recheck the wiring. Trace each lead with a colored pencil on the Pictorial as you check it. It is frequently helpful to have a friend check your work. Someone who is not familiar with the unit may notice something that you have consistently overlooked.
2. About 90% of the kits that are returned to the Heath Company for repair do not function properly due to poor connections and soldering. Therefore, you can eliminate many troubles by reheating all connections to make sure they are soldered as described in the "Soldering" section of the "Assembly Notes" on Page 5. Be sure there are no solder "bridges" between circuit board foils.
3. Check to be sure all transistors and diodes are in their proper locations. Make sure each lead is connected to the proper point. Make sure each diode band is positioned above the band printed on the circuit board.
4. Check electrolytic capacitors to be sure their positive (+) or negative (-) marked leads are in their correct locations.
5. Check to be sure the IC is properly installed in its socket, and the pins are not bent out or under the IC.
6. Check the values of the parts. Be sure in each step that you wired the correct part into the circuit, as shown in the Pictorial. It would be easy, for example, to install a 680  $\Omega$  (blue-gray-brown) resistor where a 68  $\Omega$  (blue-gray-black) resistor should have been installed.
7. Check for bits of solder, wire ends, or other foreign matter which may be lodged in the wiring.
8. A review of the "Circuit Description" may also help you determine where the trouble is.

NOTE: In an extreme case where you are unable to resolve a difficulty, refer to the "Customer Service" information inside the rear cover of this Manual. Your Warranty is located inside the front cover.

## Troubleshooting Chart

The following chart lists problems and possible causes of some troubles you might encounter. If a particular part is mentioned (Q301 for example) as a possible cause, check that part and any other components connected to it to see that they are installed

and/or wired correctly. Also check for solder bridges and poor connections in the surrounding area. It is also possible, on rare occasions, for a part to be faulty and require replacement.

CONDITION	POSSIBLE CAUSE
No + 12 volt supply.	<ol style="list-style-type: none"> <li>1. Resistor R368.</li> <li>2. Diode D314.</li> <li>3. Capacitor C354, C355, or C356.</li> </ol>
No - 12 volt supply.	<ol style="list-style-type: none"> <li>1. Resistor R367.</li> <li>2. Diode D313.</li> <li>3. Capacitor C353.</li> </ol>
Cannot adjust for zero volts at resistor R361 (during adjustments).	<ol style="list-style-type: none"> <li>1. + 12 volt supply.</li> <li>2. - 12 volt supply.</li> <li>3. Integrated circuit U301.</li> <li>4. Control R366.</li> <li>5. Capacitor C352.</li> </ol>
Cannot adjust trimmer C339 for centered screen display.	<ol style="list-style-type: none"> <li>1. Diode D312.</li> <li>2. Capacitor C337 or C336.</li> <li>3. Crystal Y301.</li> <li>4. Switch SW8 (in Station Monitor).</li> <li>5. Coil L303 or L304.</li> <li>6. Transistor Q311.</li> </ol>
Cannot adjust transformer T301 for a peak.	<ol style="list-style-type: none"> <li>1. Transformer T301 installed wrong.</li> <li>2. Transistor Q301 or Q311.</li> </ol>
Cannot adjust $\pm 20$ kHz for centered screen display.	<ol style="list-style-type: none"> <li>1. Resistor R355, R356, or R357.</li> <li>2. + 12 volt supply.</li> <li>3. - 12 volt supply.</li> </ol>
No display.	<ol style="list-style-type: none"> <li>1. Diode D309 or D310.</li> <li>2. Transistor Q309.</li> <li>3. Transistor Q311.</li> </ol>
Low sensitivity.	<ol style="list-style-type: none"> <li>1. Diodes D301 through D308.</li> <li>2. Transistor Q302.</li> </ol>
No marker.	<ol style="list-style-type: none"> <li>1. Transistor Q310.</li> <li>2. Crystal Y301.</li> <li>3. Switch SW8 wiring.</li> <li>4. + 12 volt supply.</li> </ol>
Marker pip decreases severely when you install the cover.	<ol style="list-style-type: none"> <li>1. Transformer T301 installed wrong.</li> </ol>



## SPECIFICATIONS

Input Frequency .....	3.395 or 8.830 MHz (selected by kit-builder).
IF Frequency .....	455 kHz.
IF Bandwidth .....	Greater than 1 kHz at -6 dB.
Scan Width .....	$\pm 20$ kHz or $\pm 100$ kHz (dependent upon Sweep and Horizontal Gain control settings).
Stability .....	Stable after 45 minute warmup.
Power .....	Derived from the Model HW-5404 Station Monitor.

---

The Heath Company reserves the right to discontinue products and to change specifications at any time without incurring any obligation to incorporate new features in products previously sold.

## CIRCUIT DESCRIPTION

Refer to the Schematic and the Block Diagram while you read the following paragraphs. All 300-series components are located on the pan adaptor circuit board.

The IF signal coming from the receiver is applied to the tuned mixer stage formed by transistor Q301 and its associated components. This signal is mixed with a signal from the VCO (Q311) to produce a 455 kHz IF signal.

The 455 kHz IF signal passes through filter FL301 to the logarithmic compression IF amplifier, formed by transistors Q302 through Q308. FL301 is a 1 kHz filter which provides a narrow bandwidth so you can monitor adjacent signals. The logarithmic compression IF allows you to simultaneously monitor weak and strong signals.

Diodes D309 and D310 rectify the IF signal to produce a DC pulse that is amplified by transistor Q309. This pulse is then applied to the vertical input of the Station Monitor.

Integrated circuit U301 amplifies the sweep signal coming from the Station Monitor before it is applied to the VCO circuit formed by Q311. Controls R348 and R356, and trimmer capacitor C339, set the scan width of the VCO. Controls R348 (for 100 kHz) and R356 (for 20 kHz), together with trimmer capacitor C339, center the tuned frequency on the screen.

Transistor Q310 and its associated components form a crystal oscillator that operates at the input IF frequency (3.395 MHz or 8.830 MHz). When this oscillator is on, it places a pip on the screen at the tuned frequency for quick reference.

Voltages for the +12 and -12 volt supplies are derived from the +18 volt supply in the Station Monitor (D114 through D117). Capacitors C353, C354, C355, and C356, diodes D313 and D314, and resistors R367 and R368 filter and regulate these voltages (which were rectified in the Station Monitor) to provide the operating voltages required by the Pan Adaptor.

## SEMICONDUCTOR IDENTIFICATION CHART

## DIODES

<u>COMPONENT NUMBER</u>	<u>HEATH PART NO.</u>	<u>MAY BE REPLACED WITH</u>	<u>KEY NUMBER</u>
D301	56-56	1N4149	A1
D302	56-56	1N4149	A1
D303	56-56	1N4149	A1
D304	56-56	1N4149	A1
D305	56-56	1N4149	A1
D306	56-56	1N4149	A1
D307	56-56	1N4149	A1
D308	56-56	1N4149	A1
D309	56-655	1N6263	A1
D310	56-655	1N6263	A1
D311	56-58	1N5234B	A1
D312	56-674	MV209	A2
D313	56-57	1N5242B	A1
D314	56-57	1N5242B	A1

A1

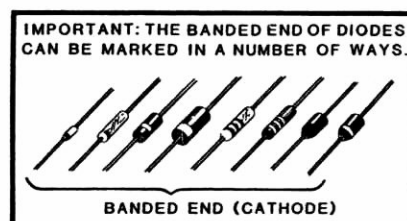

A2

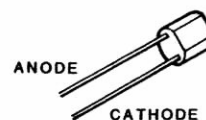

**TRANSISTORS**

<u>COMPONENT NUMBER</u>	<u>HEATH PART NO.</u>	<u>MAY BE REPLACED WITH</u>	<u>KEY NUMBER</u>
Q301	417-863	MFE131	B1
Q302	417-169	MPF105	B2
Q303	417-801	MPSA20	B3
Q304	417-801	MPSA20	B3
Q305	417-801	MPSA20	B3
Q306	417-801	MPSA20	B3
Q307	417-801	MPSA20	B3
Q308	417-801	MPSA20	B3
Q309	417-801	MPSA20	B3
Q310	417-801	MPSA20	B3
Q311	417-169	MPF105	B2

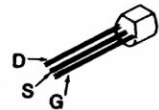

**INTEGRATED CIRCUIT**

<u>COMPONENT NUMBER</u>	<u>HEATH PART NO.</u>	<u>MAY BE REPLACED WITH</u>	<u>KEY NUMBER</u>
U301	442-22	N741V	C1

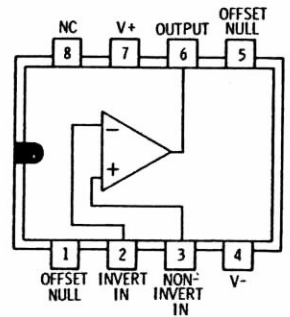
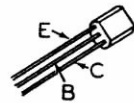

## CIRCUIT BOARD X-RAY VIEW

NOTE: To find the PART NUMBER of a component for the purpose of ordering a replacement part:

- A. Find the circuit component number (C305, R301, etc.) on the X-Ray View.
- B. Locate this same number in the "Circuit Component Number" column of the "Parts List."
- C. Adjacent to the circuit component number, you will find the PART NUMBER and DESCRIPTION which must be supplied when you order a replacement part.

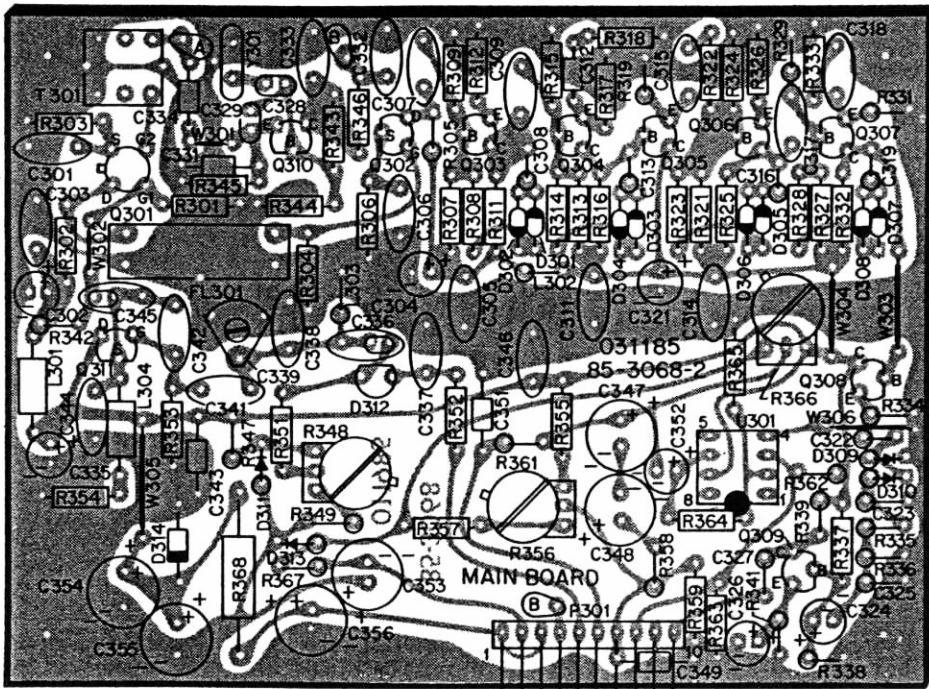

(Shown from the component side.)



# CUSTOMER SERVICE

## REPLACEMENT PARTS

Please provide complete information when you request replacements from either the factory or Heath Electronic Centers. Be certain to include the **HEATH** part number exactly as it appears in the parts list.

## ORDERING FROM THE FACTORY

Print all of the information requested on the parts order form furnished with this product and mail it to Heath. For telephone orders (parts only) dial 616 982-3571. If you are unable to locate an order form, write us a letter or card including:

- Heath part number.
- Model number.
- Date of purchase.
- Location purchased or invoice number.
- Nature of the defect.
- Your payment or authorization for COD shipment of parts not covered by warranty.

Mail letters to: Heath Company  
Benton Harbor  
MI 49022  
Attn: Parts Replacement

**Retain original parts until you receive replacements. Parts that should be returned to the factory will be listed on your packing slip.**

## OBTAINING REPLACEMENTS FROM HEATH ELECTRONIC CENTERS

For your convenience, "over the counter" replacement parts are available from the Heath Electronic Centers listed in your catalog. Be sure to bring in the original part and purchase invoice when you request a warranty replacement from a Heath Electronic Center.

## TECHNICAL CONSULTATION

Need help with your kit? — Self-Service? — Construction? — Operation? — Call or write for assistance. you'll find our Technical Consultants eager to help with just about any technical problem except "customizing" for unique applications.

The effectiveness of our consultation service depends on the information you furnish. Be sure to tell us:

- The Model number and Series number from the blue and white label.
- The date of purchase.
- An exact description of the difficulty.
- Everything you have done in attempting to correct the problem.

Also include switch positions, connections to other units, operating procedures, voltage readings, and any other information you think might be helpful.

**Please do not send parts for testing**, unless this is specifically requested by our Consultants.

Hints: Telephone traffic is lightest at midweek — please be sure your Manual and notes are on hand when you call.

Heathkit Electronic Center facilities are also available for telephone or "walk-in" personal assistance.

## REPAIR SERVICE

Service facilities are available, if they are needed, to repair your completed kit. (Kits that have been modified, soldered with paste flux or acid core solder, cannot be accepted for repair.)

**If it is convenient, personally deliver your kit to a Heathkit Electronic Center. For warranty parts replacement, supply a copy of the invoice or sales slip.**

If you prefer to ship your kit to the factory, attach a letter containing the following information directly to the unit:

- Your name and address.
- Date of purchase and invoice number.
- Copies of all correspondence relevant to the service of the kit.
- A brief description of the difficulty.
- Authorization to return your kit COD for the service and shipping charges. (This will reduce the possibility of delay.)

Check the equipment to see that all screws and parts are secured. (Do not include any wooden cabinets or color television picture tubes, as these are easily damaged in shipment. Do not include the kit Manual.) Place the equipment in a strong carton with at least **THREE INCHES** of *resilient* packing material (shredded paper, excelsior, etc.) on all sides. Use additional packing material where there are protrusions (control sticks, large knobs, etc.). If the unit weighs over 15 lbs., place this carton in another one with 3/4" of packing material between the two.

Seal the carton with reinforced gummed tape, tie it with a strong cord, and mark it "Fragile" on at least two sides. Remember, the carrier will not accept liability for shipping damage if the unit is insufficiently packed. Ship by prepaid express, United Parcel Service, or insured Parcel Post to:

Heath Company  
Service Department  
Benton Harbor, Michigan 49022



HEATH COMPANY • BENTON HARBOR, MICHIGAN  
**THE WORLD'S FINEST ELECTRONIC EQUIPMENT IN KIT FORM**

LITHO IN U.S.A.